

ITECH ELECTRONIC

IT2700

Multi-channel Modular Power System



www.itechate.com

 **ITECH**

IT2700

Multi-channel Modular Power System

IT2700 series multi-channel modular power system brings ultra-high power density. The 1U main frame can include up to 8 modules (200W each) or 4 modules (500W each). Different modules can be grouped and synchronized. The modules could be bidirectional DC power supplies, DC power supplies or regenerative loads. They have built-in LAN, USB, CAN, digital I/O and free PC software. It can be widely used in ATE integration in R&D, design verification and manufacturing of DC-DC converter, communication power semiconductors, 3C products, like smartphone, PCBA, battery simulation and test, chips BMS chips etc.

Features

- ATE systems for R&D, design verification and manufacturing
- Compact size: 1U single unit outputs up to 8 channels
- Flexible modular system: mix and match various modules
- 2 mainframes (1U), 3 module types (DC power supply, bidirectional power supply, regenerative load)
- Free PC software, display 8-channel output
- Support Web control, use common browser to realize all functions
- The electrically isolated source load module supports 8 modules in master-slave parallel connection up to 2kW*3
- Load function: support CC, CV, CP, CR, CC+CV, CR+CV, CP+CV, CC+CR, AUTO,BSIM (battery simulation)
- Supports automatic switching for CV, CC, and CP, with selectable CC & CV priority, and internal resistance setting.
- Bidirectional power supply module supports resistance setting in load mode
- All modules are wide-range modules
- Single module voltage up to 150V, current up to 30A, power up to 500W
- Supports synchronous control between different frames, no upper limit of channels
- Rich trigger output and input, support step trigger output, can trigger other modules (acquisition, oscilloscope, data recording, etc.)
- Up to 50kHz external data recording function to improve test efficiency
- Measurement functions: multi-output/single-output display, oscilloscope, data record display, supports average, minimum and maximum values of V/I/P, and calculates P, Ah and Wh for all outputs
- Output functions: list function, arbitrary waveform, swept sine wave, arbitrary wave sequence, constant dwell arbitrary wave, load transient, battery simulation*1, battery test, OCP and OPP test*2, output on/off serialization, Watchdog, support output coupling
- Full protection: OVP, UVP, OCP, OPP, OTP, UCP, Foldback, supports protection coupling
- Modules has anti-reverse connection function, built-in relay, and supports anti-discharge and anti-surge functions
- AC input: adaptive 100-380 V ac single phase
- Built-in LAN, USB-TMC,USB-VCP, CAN, digital I/O, data import and export by USB and supports SCPI protocol

*1 only available for bidirectional power supply modules only

*2 only available for load modules

*3 One chassis supports only one set of master-slave parallel connections



DC-DC function verification



Design verification of electronic products



Battery cell simulation and test



Chip test



IT2702 1U frame without front panel



IT2703 1U frame with touch screen

Your Power Testing Solution

IT2700 Multi-channel Modular Power System

Voltage	Current	Power	DC power supply *	Bidirectional DC power supply *	Regenerative DC load *
30V	15A	200W	IT27134/IT27134R	IT27334/IT27334R	IT27534/IT27534R
	30A	500W (2 slots occupied)	IT27154/IT27154R	IT27354/IT27354R	IT27554/IT27554R
60V	10A	200W	IT27135/IT27135R	IT27335/IT27335R	IT27535/IT27535R
	20A	500W (2 slots occupied)	IT27155/IT27155R	IT27355/IT27355R	IT27555/IT27555R
150V	5A	200W	IT27137/IT27137R	IT27337/IT27337R	IT27537/IT27537R
	10A	500W (2 slots occupied)	IT27157/IT27157R	IT27357/IT27357R	IT27557/IT27557R
IT2702	1U mainframe without front panel (8 slots)				
IT2703	1U mainframe with touch screen (6 slots)				
IT2704	1U mainframe without front panel (8 slots, only available for load modules)				

*IT27xxx should be equipped with IT2702 or IT2704

*IT27xxxR should be equipped with IT2703

List Sequence

By editing the voltage, current, pulse width and slope of each step, it can generate a variety of complex sequences, help you complete various loading tests and import or export the files.

No.	Curr(A)	Slope(A/ms)	Time(s)	Pace	B0Step	EOStep
1	1.000	0.100	1.000	Auto	On	On
2	2.000	0.100	1.000	Auto	On	Off

- Up to 2000 steps can be set for each list file
- Support infinite loop
- CV, CC,CP,CR mode
- Voltage
- Current
- Slope
- Supports automatic jump or wait for trigger before jump
- Generates pre-step trigger or post-step trigger output

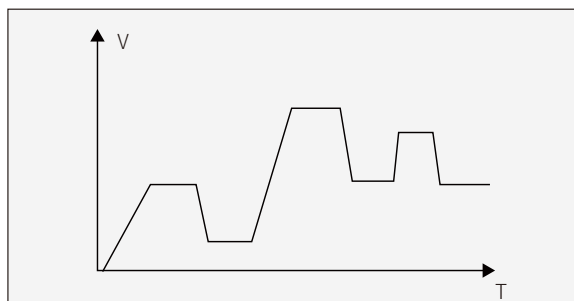

CC&CV Priority

Application: test of diodes, laser diodes, LEDs, power semiconductor components

IT2700 power supply and bidirectional power supply modules allow you to select the response priority of the CV/CC loop to determine whether the output is a voltage high-speed mode or a current non-overshoot mode, adapting to different DUTs.

Your Power Testing Solution

IT2700 Multi-channel Modular Power System

Multiple Operation Modes

IT2700 load provides 10 operating modes. In addition to CC, CV, CR, and CP, it also includes 5 compound modes: CC+CR mode, which is often used in OBC voltage limiting, current limiting characteristic tests, constant voltage accuracy, and constant current accuracy tests to avoid OCP of the OBC. The CR+CV mode is used to simulate LED lights, test the LED power supply, and acquires the current ripple. The CP+CV mode can replace the VON point setting or be used for battery discharge testing, and the voltage setting point can be used as the cut-off voltage. CC+CV mode can be used to simulate batteries, test charging piles or chargers, and limit the maximum load current while CV is working. AUTO mode allows it to be automatically switch between CV, CR, CC and CP modes. When the DUT's protection circuit is damaged, the mode can be automatically switched to avoid DUT damage.

BSIM (Battery Simulation) mode can output a voltage to simulate a battery for testing chargers and other equipment.

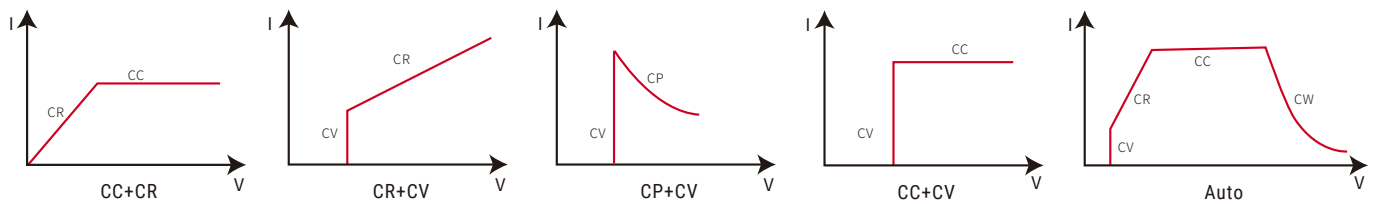

Output On/Off Serialization

The on/off delay function for each output allows you to serialize the on/off of the output.

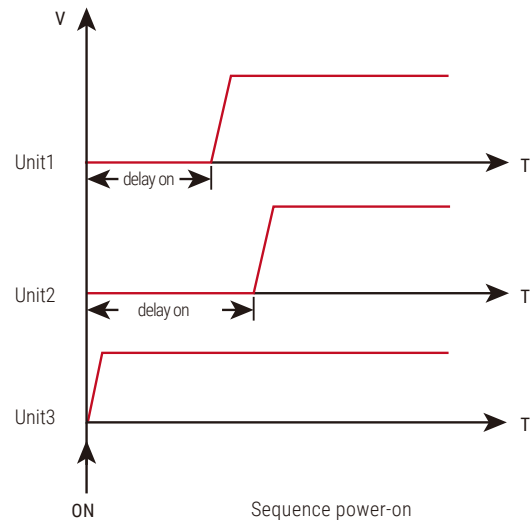
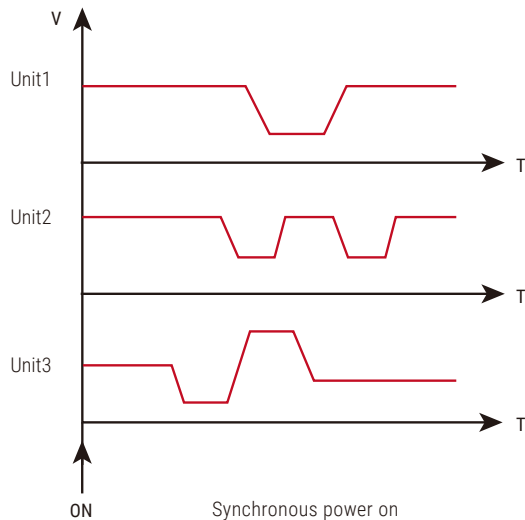

Output	Coupling	Group	General	Comm	Digital IO	Preference		
1								
2								
3								
4								
5								
6								
7								
8								
Delays (s)								
On	0.000	0.000	2.000	0.000	4.000	0.000	6.000	0.000
Off	0.000	0.000	2.000	0.000	4.000	0.000	6.000	0.000

Multi-channel Sequence Power-on

Application: chip power-on sequence test/CPU power management chip test

- When multiple power supplies need to output at the same time
- The DUT has multiple inputs and is powered on in a certain timing sequence
- TFT/LCD test, computer PCB test

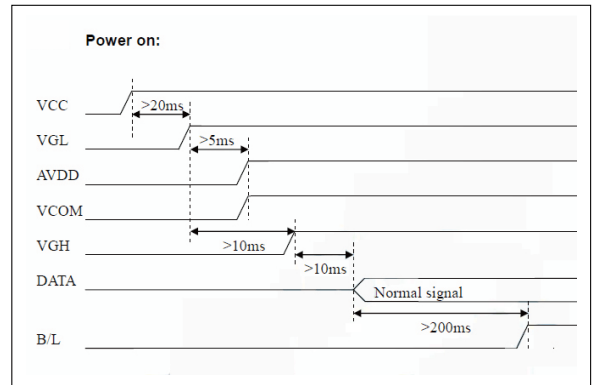

Battery Simulation

IT2700 bidirectional power supply modules have built-in battery simulation function. It can simulate parallel connection of multiple battery modules. You can set the battery's initial state, charge and discharge cutoff state, and you can import battery curves or customize simple battery models, such as battery full charge, power loss voltage, battery internal resistance ESR, etc.

Typical DUTs



+Current	-Current	SOC High Limit	SOC Low Limit
10.000A	-1.000A	102%	-2%
Series	Parallel	End	Battery Type
2	2	Off	Curve
Import	Export	Full-V:12.000V	Capacity
		Empty-V:5.000V	200mAh
<input type="radio"/> Initial Voltage	<input type="radio"/> Initial Capacity	<input checked="" type="radio"/> Initial SOC	
3.200V	20mAh	2.0%	

Single Cell Properties

98.8%	30.0005V	Run	< CH1 >
Initial SOC	10.0005A	Capacity	12:34:56
20.000%	300.00W	5.00mAh	12.469Wh
CV	Open	VOC	82.123Ah
New	Edit	30.00Vpk+	30.00Vpk+
Delete	Battery Sim	20.000Apk+	20.000Apk+

Your Power Testing Solution

IT2700 Multi-channel Modular Power System

Power Optimizer Test

A solar power optimizer is a DC/DC converter. It maximizes production efficiency through MPPT tracking of each module.

Test purpose

Low-voltage, high-current, high-voltage and low-current production lines calibrate input and output voltage, current, efficiency and stability

Test method

Select the IT2700 power supply and load modules and connect them to the input and output of the power optimizer respectively

Advantages

01 Compacted size with multiple channels

02 Synchronize testing to improve efficiency

03 Flexible combination of modules

04 Power extension by parallel connection, multiple options

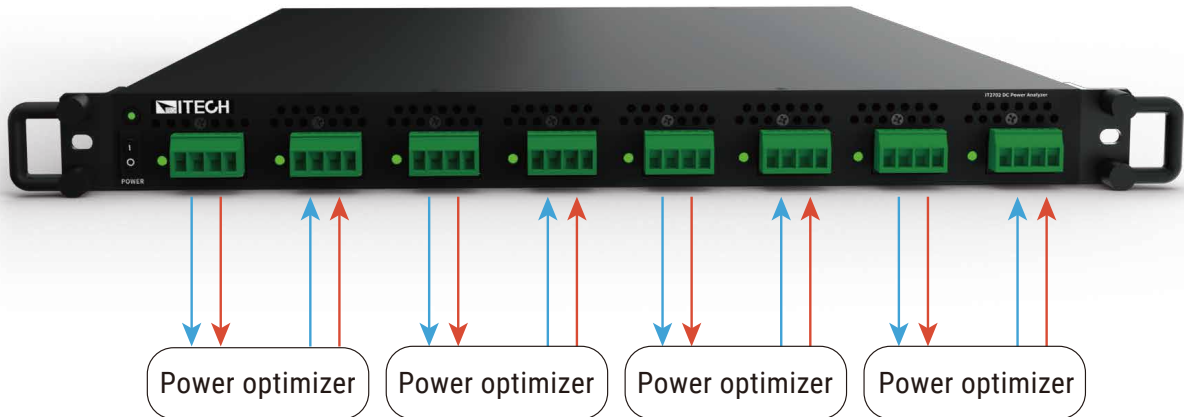

High-speed Dynamic Recovery Time

- IT2700 power module has high-speed dynamic recovery capability. Dynamic recovery time refers to the time required for the power supply output voltage to return to its specified value or steady state when the load changes.
- It maintains stable output, which is particularly important for the test performance of high-precision equipment.
- For high-performance computers, communication equipment and other high-speed electronic products, fast dynamic response helps ensure the best and stable performance of the equipment running at high speeds.
- It has a wider range of applications, such as medical equipment, industrial automation, etc.

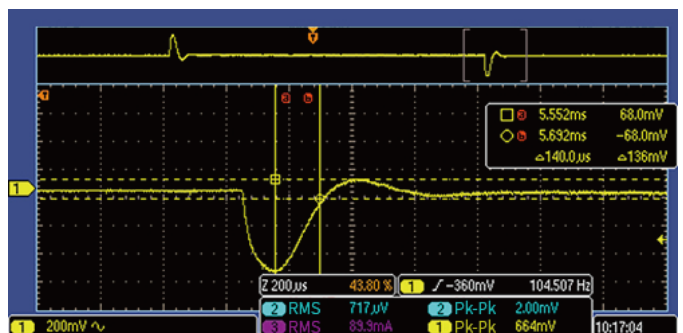

60V full voltage, 50%-100% load (50Hz)
At LOW loop speed, 10%-90% of the steady-state value,
the recovery time is 140µs

Your Power Testing Solution

IT2700 Multi-channel Modular Power System

Max. 240 Channels In a Single Cabinet



240 Channels

Multi-channel control via PC or front panel, single cabinet can output up to 240 channels

Meet the needs for high efficiency, cost reduction and diverse independent testing of production lines

Master-slave parallelization of modules in each unit, synchronization error <math><4\mu\text{s}</math>

Coupling - Channel Grouping Function

Controlled by LAN, no limit of channels

Grouping with different frames

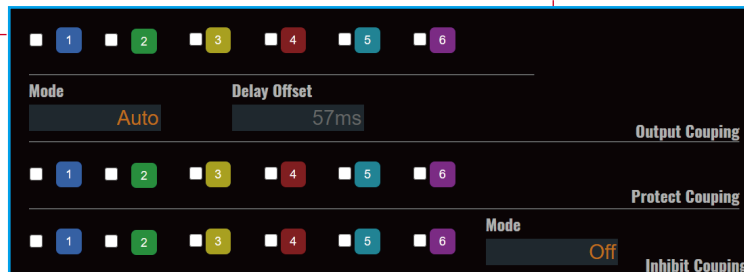

Control includes setting voltage and current
|ON by group|Start a function
|Trigger

Output grouping, protection grouping and stop output grouping (emergency stop grouping) can be set separately

Motor Testing - Safety Assurance

Inhibit output prohibition provides more complete interlock linkage protection for automated test systems. When external abnormal signals are received, emergency stop and other abnormal protection can be triggered.

IT2700 is equipped with digital IO interface. When the motor runs abnormally, the motor outputs an abnormal signal (high/low) and transmits it to the inhibit terminal of the digital IO, and at the same time controls the power supply to turn off the output, thereby protecting the DUT.

DUT: DC servo motor



Digital IO Inhibit terminal



Your Power Testing Solution

IT2700 Multi-channel Modular Power System

Arbitrary Waveform (Arb)

- Generate waveforms like steps, ramps, trapezoid, user-defined, sine waves, pulses, staircase, exponential.
- Arb Waveform generator enables biased AC (>0V)
- Supports uploading 4000-point waveforms

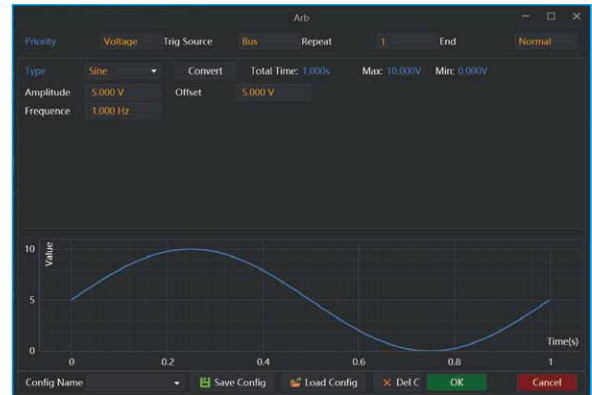
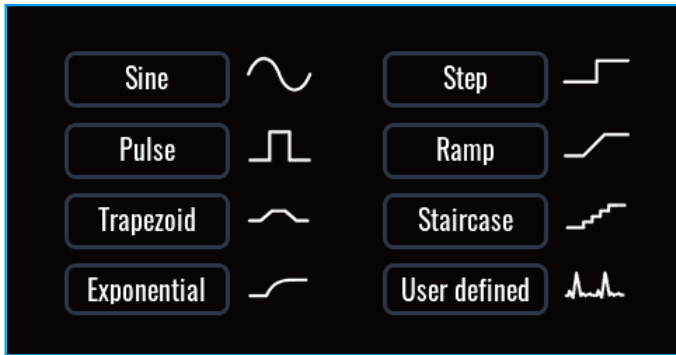

Arbitrary Waveform Sequence (Arb Sequence)

PV2700 can run multiple different arbitrary waveforms one after another, and the ARB sequence can contain any standard ARB type.

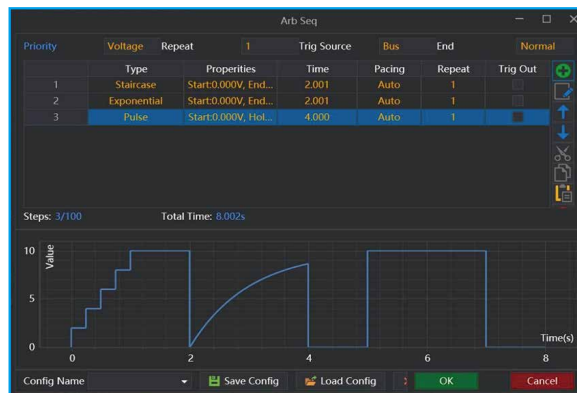

Sweeping Sine Wave (Sweep)

- Support sine wave amplitude, bias and frequency sweeps
- Available for power supply, bidirectional power supply, and load modules
- Be used to evaluate the stability, efficiency and heating of the DUT

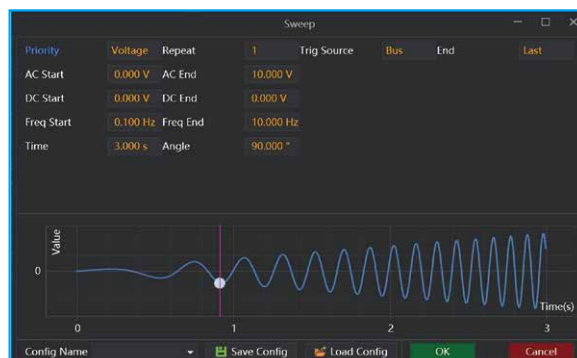

Constant Dwell Arbitrary Waveforms

- Supports users to import captured waveforms, and all points share the same dwell time. CDARB (const dwell arb) is a digital simulation function. Users can replay the sampled voltage or current, power, and resistance waveforms at equal intervals. In theory it can be data for a long period of time and can be used in conjunction with the recorder. One for recording data and the other for playback data. Constant dwell time arbitrary waveform, which can be used by users to reproduce arbitrary waveforms.
- Time intervals are equal, and the default setting is the fastest slope.

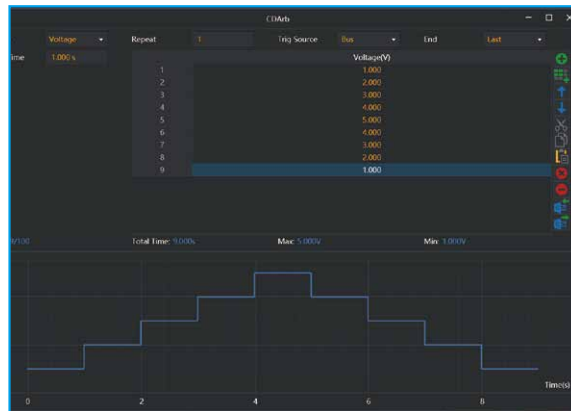

Data Recording Display

PV2700 can record and display the average, minimum and maximum values of voltage, current and power over a period of time. The maximum frequency is 50kHz, and the measurement results can be calculated by adjusting the markers. The measurement results include maximum value, minimum value, average value, peak-to-peak value, ampere-hour, watt-hour and interval time.

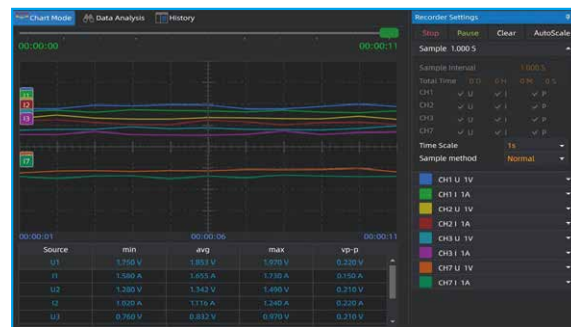

Oscilloscope Display

PV2700 can capture up to 16 output voltage and/or current waveforms simultaneously, and can display 6 waveforms simultaneously, with a frequency of up to 200kHz, a maximum of 600kpts., and a resolution of up to 16 bits. The measurement results can be calculated by adjusting the markers. The measurement results include maximum value, minimum value, average value, peak-to-peak value, interval time, etc. It supports common oscilloscope functions such as triggering, rolling and single capture.

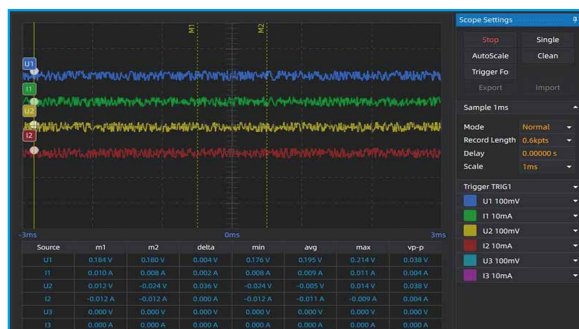

Your Power Testing Solution

IT2700 Multi-channel Modular Power System

48V System - 5G Communication Power Supply, Data Center

- The communications industry uses 48V as the standard voltage
- 5G communications require the use of Massive MIMO technology. The AAU single-sector output power of 5G base stations increases from 4G's 40W and 80W to 200W or even higher.

Advantages tested with IT2700

- IT2700 bidirectional power module can simulate batteries and conduct multi-channel power supply tests
- Regenerative load modules can be used for aging test
- Parallel connection to adapt to more DUTs

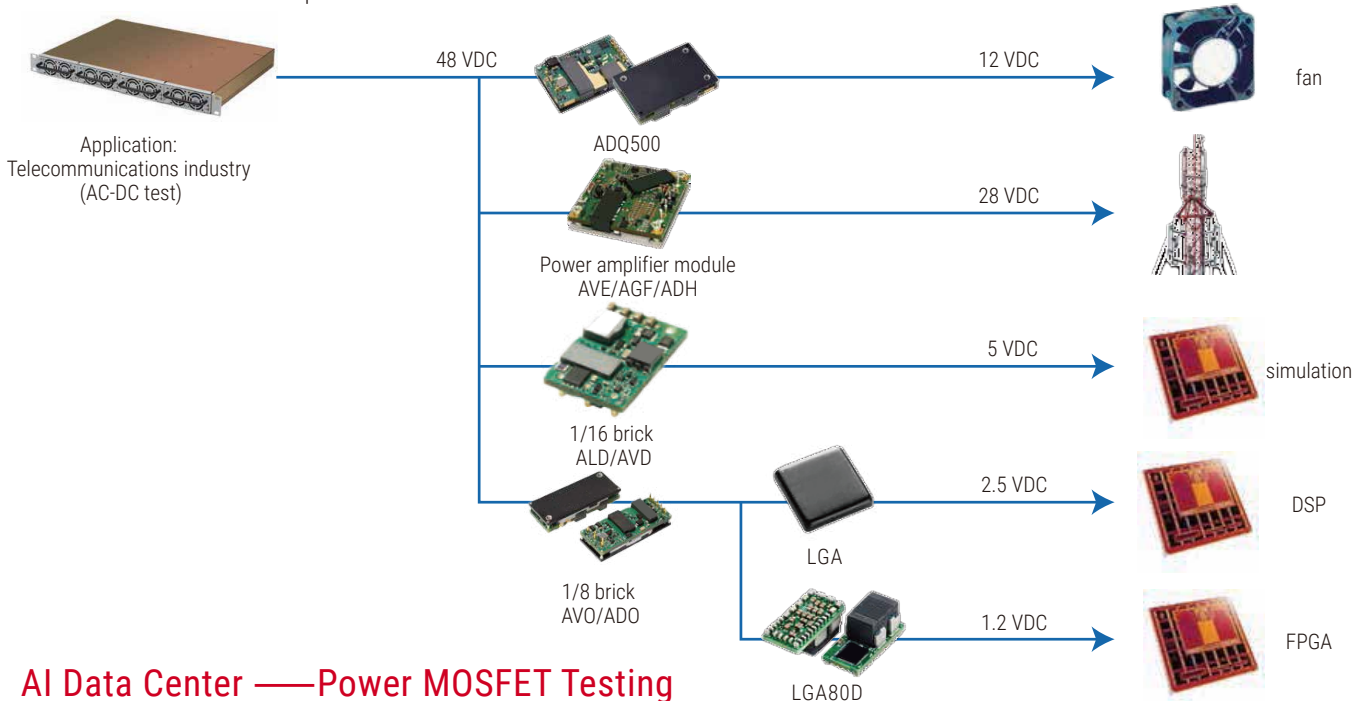

AI Data Center — Power MOSFET Testing

As the demand for cloud computing, artificial intelligence applications, and high-power processors and accelerators continues to grow, data centers continue to evolve to accommodate new high-power needs, including microprocessors, GPUs, FPGAs, and ASICs requiring higher power levels. The power consumption of advanced processors, including Intel's "Sky Lake" and AMD's "Rome", has also risen to 230-300W, and Nvidia's GPU power consumption will climb to about 600W.

Advantages tested with IT2700

- Compact
- Multiple channels
- Current and power extended in parallel/serial connection

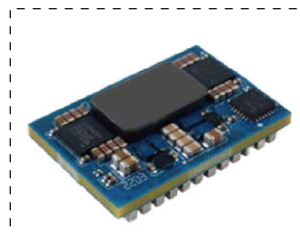

DC/DC power module, up to 300W continuous power
The module supports input voltages up to 60V

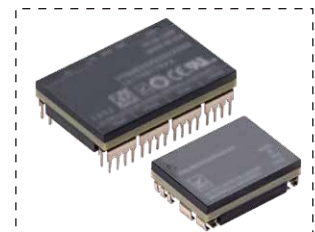

24V to 60V, 15A, can be connected in parallel
Electric fuse solution

Your Power Testing Solution

IT2700 Multi-channel Modular Power System

Advantages Of Production Line Aging Test

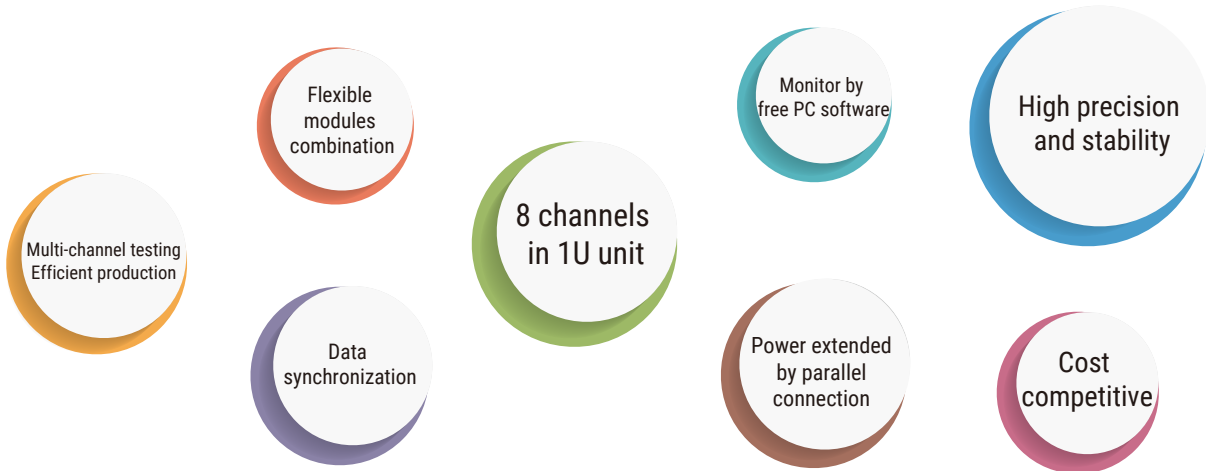

Cabinet Mounting Kits

These instruments can be mounted in a standard 19-inch cabinet.

When the instrument is mounted to the ITECH cabinet, select the combo kit: IT-E155A* (front mounting ear) + IT-E155C;

When the instrument is mounted on another cabinet, it is recommended to choose the combo kit: IT-E155A* (front mounting ears) + IT-E155B, no tray required, this kit can be adjusted according to the cabinet depth.

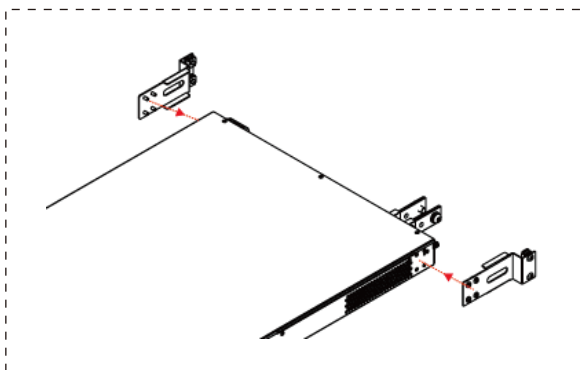

IT-E155C

When using the ITECH cabinet, it can be used with IT-E155A

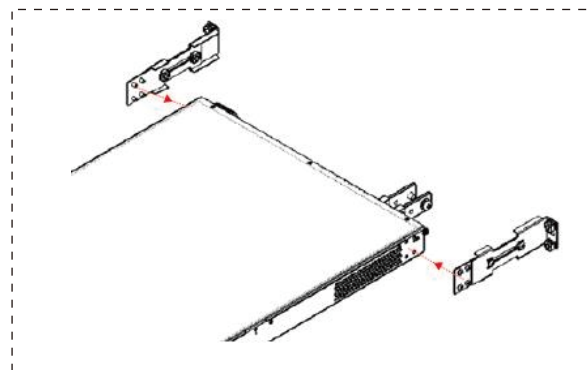

IT-E155B

When use a non-ITECH cabinet with IT-E155A

* Note: The IT-E155A front mounting ear is standard for IT2702/IT2704 chassis and optional for IT2703, which is not shown in the figure above.

Your Power Testing Solution

IT2700 Multi-channel Modular Power System

IT2702		
AC input	voltage	Single phase 100V~380V
	frequency	50/60Hz
Max. AC apparent power		2.3kVA
Max. AC current ^{*1}		12.5Aac
Max. efficiency		95%
PF		0.99
DC component		≤0.2A
Current harmonic		≤3%
Communication interface		USB/LAN/CAN/Digital IO
Program response		0.1ms
Max. channels		8
Working temperature		0~40°C
Store temperature		-10°C~70°C
Protection level		IP20
Withstand voltage (AC to ground)		3500Vdc
Cooling		fan
Dimension		580mm*437mm*43.5mm
N.W.		9kg

*1 The AC current is limited to 12.5Aac. When the mains voltage is low, power may be limited. For example: single-phase mains, phase voltage 100Vac, the power is: $P = 100\text{Vac} * 12.5\text{Aac} = 1250\text{VA}$

IT2703		
AC input	voltage	Single phase 100V~240V
	frequency	50/60Hz
Max. AC apparent power		1.8kVA
Max. AC current ^{*1}		10Aac
Max. efficiency		95%
PF		0.99
DC component		≤0.2A
Current harmonic		≤3%
Communication interface		USB/LAN/CAN/Digital IO
Program response		0.1ms
Max. channels		6
Display		4.28"
Display resolution		800*200
Working temperature		0~40°C
Store temperature		-10°C~70°C
Protection level		IP20
Withstand voltage (AC to ground)		3500Vdc
Cooling		fan
Dimension		580mm*437mm*43.5mm
N.W.		10kg

*1 The AC current is limited to 10Aac. When the mains voltage is low, power may be limited. For example: single-phase mains, phase voltage 100Vac, the power is: $P = 100\text{Vac} * 10\text{Aac} = 1000\text{VA}$

Your Power Testing Solution

IT2700 Multi-channel Modular Power System

		IT27134	IT27135	IT27137
Rated values	voltage	0~30V	0~60V	0~150V
	current	0~15A	0~10A	0~5A
	power	0~200W	0~200W	0~200W
	series IR (CV priority)	0~1Ω	0~1Ω	0~1Ω
Setup resolution	voltage	0.001V	0.001V	0.01V
	current	0.001A	0.001A	0.001A
	power	0.01W	0.01W	0.01W
	series IR (CV priority)	0.0001Ω	0.0001Ω	0.0001Ω
Readback resolution	voltage	0.0001V	0.0001V	0.0001V
	current	0.0001A	0.0001A	0.0001A
	power	0.01W	0.01W	0.01W
Set accuracy	voltage	≤0.02% + 0.02%FS	≤0.02% + 0.02%FS	≤0.02% + 0.02%FS
	current	≤0.05% + 0.05%FS	≤0.05% + 0.05%FS	≤0.05% + 0.05%FS
	power	≤0.1% + 0.2%FS	≤0.1% + 0.2%FS	≤0.1% + 0.2%FS
	series IR (CV priority)	≤1%FS	≤1%FS	≤1%FS
Readback accuracy	voltage	≤0.02% + 0.02%FS	≤0.02% + 0.02%FS	≤0.02% + 0.02%FS
	current	≤0.05% + 0.05%FS	≤0.05% + 0.05%FS	≤0.05% + 0.05%FS
	power	≤0.1% + 0.2%FS	≤0.1% + 0.2%FS	≤0.1% + 0.2%FS
Voltage ripple	Vpeak	≤30mVpp	≤60mVpp	≤150mVpp
	RMS	≤5mV	≤10mV	≤15mV
Setup temperature coefficient	voltage	≤20ppm/°C	≤20ppm/°C	≤20ppm/°C
	current	≤30ppm/°C	≤30ppm/°C	≤30ppm/°C
Readback temperature coefficient	voltage	≤20ppm/°C	≤20ppm/°C	≤20ppm/°C
	current	≤30ppm/°C	≤30ppm/°C	≤30ppm/°C
Rise time(no load)	voltage	≤10ms	≤10ms	≤10ms
Rise time(full load))	voltage	≤20ms	≤20ms	≤20ms
Rise time(no load)	voltage	≤0.5s	≤0.5s	≤0.5s
Rise time(full load)	voltage	≤10ms	≤10ms	≤10ms
Dynamic response time *1	voltage	≤1ms	≤1ms	≤1ms
Power regulation	voltage	≤0.005% + 0.005%FS	≤0.005% + 0.005%FS	≤0.005% + 0.005%FS
	current	≤0.015% + 0.015%FS	≤0.015% + 0.015%FS	≤0.015% + 0.015%FS
Load regulation	voltage *2	≤0.005% + 0.005%FS	≤0.005% + 0.005%FS	≤0.005% + 0.005%FS
	current	≤0.015% + 0.015%FS	≤0.015% + 0.015%FS	≤0.015% + 0.015%FS
Output protection	OCP	15.3A	10.2A	5.1A
	OVP	30.6V	61.2V	153V
	OPP	204W	204W	204W
Sense		≤3V	≤6V	≤15V
Isolation(DC to ground)		800Vdc	800Vdc	800Vdc
Working temperature		0~40°C	0~40°C	0~40°C
Store temperature		-10°C~70°C	-10°C~70°C	-10°C~70°C
Protection level		IP20	IP20	IP20
Cooling		fan	fan	fan
Dimension		320mm*50mm*40mm	320mm*50mm*40mm	320mm*50mm*40mm
N.W.		0.6kg	0.6kg	0.6kg

*1 rated current: 10% to 90%

*2 sense mode

Your Power Testing Solution

IT2700 Multi-channel Modular Power System

		IT27334	IT27335	IT27337
Rated values	voltage	0~30V	0~60V	0~150V
	current	-15A~15A	-10A~10A	-5A~5A
	power	-200W~200W	-200W~200W	-200W~200W
	series IR (CV priority)	0~1Ω	0~1Ω	0~1Ω
	load IR (CC priority)	0.02Ω~200Ω	0.06Ω~600Ω	0.3Ω~3000Ω
Setup resolution	voltage	0.001V	0.001V	0.01V
	current	0.001A	0.001A	0.001A
	power	0.01W	0.01W	0.01W
	series IR (CV priority)	0.0001Ω	0.0001Ω	0.0001Ω
	load IR (CC priority)	0.01Ω	0.01Ω	0.01Ω
Readback resolution	voltage	0.0001V	0.0001V	0.0001V
	current	0.0001A	0.0001A	0.0001A
	power	0.01W	0.01W	0.01W
Set accuracy	voltage	≤0.02% + 0.02%FS	≤0.02% + 0.02%FS	≤0.02% + 0.02%FS
	current	≤0.05% + 0.05%FS	≤0.05% + 0.05%FS	≤0.05% + 0.05%FS
	power	≤0.1% + 0.2%FS	≤0.1% + 0.2%FS	≤0.1% + 0.2%FS
	series IR (CV priority)	≤1%FS	≤1%FS	≤1%FS
	load IR (CC priority)	max: 1/(1/Rset+(1/Rset)*0.05+0.0005) min: 1/(1/Rset-(1/Rset)*0.05-0.0005)	max: 1/(1/Rset+(1/Rset)*0.05+0.0005) min: 1/(1/Rset-(1/Rset)*0.05-0.0005)	max: 1/(1/Rset+(1/Rset)*0.05+0.0005) min: 1/(1/Rset-(1/Rset)*0.05-0.0005)
Readback accuracy	voltage	≤0.02% + 0.02%FS	≤0.02% + 0.02%FS	≤0.02% + 0.02%FS
	current	≤0.05% + 0.05%FS	≤0.05% + 0.05%FS	≤0.05% + 0.05%FS
	power	≤0.1% + 0.2%FS	≤0.1% + 0.2%FS	≤0.1% + 0.2%FS
Voltage ripple	Vpeak	≤30mVpp	≤60mVpp	≤150mVpp
	RMS	≤5mV	≤10mV	≤15mV
Setup temperature coefficient	voltage	≤20ppm/°C	≤20ppm/°C	≤20ppm/°C
	current	≤30ppm/°C	≤30ppm/°C	≤30ppm/°C
Readback temperature coefficient	voltage	≤20ppm/°C	≤20ppm/°C	≤20ppm/°C
	current	≤30ppm/°C	≤30ppm/°C	≤30ppm/°C
Rise time(no load)	voltage	≤10ms	≤10ms	≤10ms
Rise time(full load)	voltage	≤20ms	≤20ms	≤20ms
Rise time(no load)	voltage	≤10ms	≤10ms	≤10ms
Rise time(full load)	voltage	≤10ms	≤10ms	≤10ms
Dynamic response time *1	voltage	≤1ms	≤1ms	≤1ms
Power regulation	voltage	≤0.005% + 0.005%FS	≤0.005% + 0.005%FS	≤0.005% + 0.005%FS
	current	≤0.015% + 0.015%FS	≤0.015% + 0.015%FS	≤0.015% + 0.015%FS
Load regulation	voltage *2	≤0.005% + 0.005%FS	≤0.005% + 0.005%FS	≤0.005% + 0.005%FS
	current	≤0.015% + 0.015%FS	≤0.015% + 0.015%FS	≤0.015% + 0.015%FS
Output protection	OCP	-15.3A or 15.3A	-10.2A or 10.2A	-5.1A or 5.1A
	OVP	30.6V	61.2V	153V
	OPP	-204W or 204W	-204W or 204W	-204W or 204W
Sense		≤3V	≤6V	≤15V
Isolation(DC to ground)		800Vdc	800Vdc	800Vdc
Working temperature		0~40°C	0~40°C	0~40°C
Store temperature		-10°C~70°C	-10°C~70°C	-10°C~70°C
Protection level		IP20	IP20	IP20
Cooling		风冷	风冷	风冷
Dimension		320mm*50mm*40mm	320mm*50mm*40mm	320mm*50mm*40mm
N.W.		0.6kg	0.6kg	0.6kg

*1 rated current: 10% to 90%

*2 sense mode

Your Power Testing Solution

IT2700 Multi-channel Modular Power System

		IT27534	IT27535	IT27537
Rated values	voltage	0.03V~30V	0.06V~60V	0.150V~150V
	current	0~15A	0~10A	0~5A
	power	0~200W	0~200W	0~200W
	resistance *	0.02Ω~200Ω	0.06Ω~600Ω	0.3Ω~3000Ω
	MOV.	0.3V at 15A	0.6V at 10A	1.5V at 5A
	input leakage current	0.001A	0.001A	0.001A
Setup resolution	voltage	0.001V	0.001V	0.01V
	current	0.001A	0.001A	0.001A
	power	0.01W	0.01W	0.01W
	resistance	0.01Ω	0.01Ω	0.01Ω
Readback resolution	voltage	0.0001V	0.0001V	0.0001V
	current	0.0001A	0.0001A	0.0001A
	power	0.01W	0.01W	0.01W
Set accuracy	voltage	≤0.02% + 0.02%FS	≤0.02% + 0.02%FS	≤0.02% + 0.02%FS
	current	≤0.05% + 0.05%FS	≤0.05% + 0.05%FS	≤0.05% + 0.05%FS
	power	≤0.1% + 0.2%FS	≤0.1% + 0.2%FS	≤0.1% + 0.2%FS
	resistance *1	max: 1/(1/Rset+(1/Rset)*0.05+0.0005) min: 1/(1/Rset-(1/Rset)*0.05-0.0005)	max: 1/(1/Rset+(1/Rset)*0.05+0.0005) min: 1/(1/Rset-(1/Rset)*0.05-0.0005)	max: 1/(1/Rset+(1/Rset)*0.05+0.0005) min: 1/(1/Rset-(1/Rset)*0.05-0.0005)
Readback accuracy	voltage	≤0.02% + 0.02%FS	≤0.02% + 0.02%FS	≤0.02% + 0.02%FS
	current	≤0.05% + 0.05%FS	≤0.05% + 0.05%FS	≤0.05% + 0.05%FS
	power	≤0.1% + 0.2%FS	≤0.1% + 0.2%FS	≤0.1% + 0.2%FS
Setup temperature coefficient	voltage	≤20ppm/°C	≤20ppm/°C	≤20ppm/°C
	current	≤30ppm/°C	≤30ppm/°C	≤30ppm/°C
Readback temperature coefficient	voltage	≤20ppm/°C	≤20ppm/°C	≤20ppm/°C
	current	≤30ppm/°C	≤30ppm/°C	≤30ppm/°C
Dynamic response time	rise time	15A/ms	10A/ms	5A/ms
	fall time	15A/ms	10A/ms	5A/ms
	dynamic frequency	500Hz	500Hz	500Hz
Power regulation	voltage	≤0.005% + 0.005%FS	≤0.005% + 0.005%FS	≤0.005% + 0.005%FS
	current	≤0.015% + 0.015%FS	≤0.015% + 0.015%FS	≤0.015% + 0.015%FS
Load regulation	voltage *2	≤0.005% + 0.005%FS	≤0.005% + 0.005%FS	≤0.005% + 0.005%FS
	current	≤0.015% + 0.015%FS	≤0.015% + 0.015%FS	≤0.015% + 0.015%FS
Short circuit current	current	15.75A	10.5A	5.25A
Input protection	OCP	15.3A	10.2A	5.1A
	OVP	30.6V	61.2V	153V
	OPP	204W	204W	204W
Input OVP		31.5V	63V	156V
Sense		≤3V	≤6V	≤15V
Isolation(DC to ground)		800Vdc	800Vdc	800Vdc
Working temperature		0~40°C	0~40°C	0~40°C
Store temperature		-10°C~70°C	-10°C~70°C	-10°C~70°C
Protection level		IP20	IP20	IP20
Cooling		fan	fan	fan
Dimension		320mm*50mm*40mm	320mm*50mm*40mm	320mm*50mm*40mm
N.W.		0.6kg	0.6kg	0.6kg

*1 resistance accuracy-voltage and current not less than 10%FS

*2 sense mode

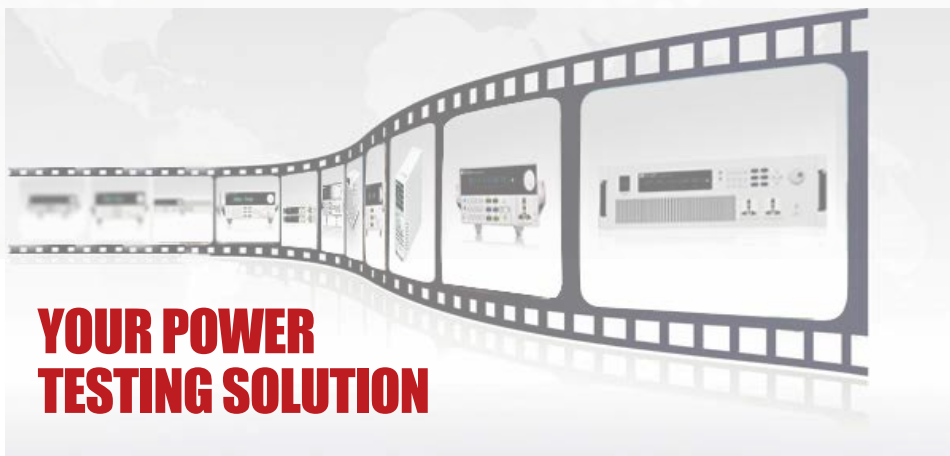
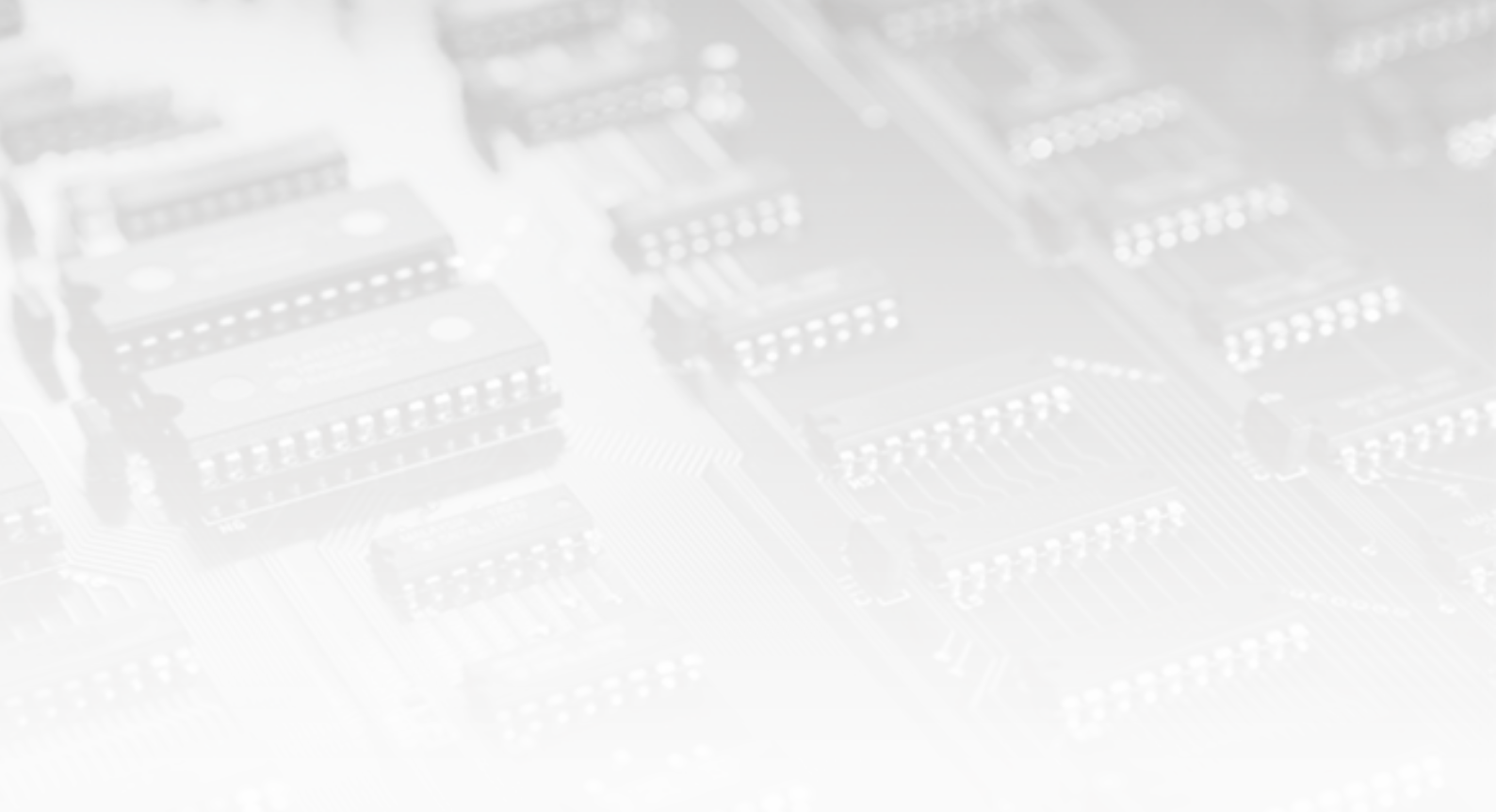

This information is subject to change without notice. For more information, please contact ITECH.

Taipei

Add: No.918, Zhongzheng Rd., Zhonghe Dist., New Taipei City 235, Taiwan
Web: www.itechate.com
TEL: +886-3-6684333
E-mail: info@itechate.com

Factory I

Add: No.108, XiShanqiao Nanlu, Nanjing city, 210039, China
TEL: +86-25-52415098
Web: www.itechate.com

Factory II

Add: No.150, Yaonanlu, Meishan Cun, Nanjing city, 210039, China
TEL: +86-25-52415099
Web: www.itechate.com



ITECH Web



ITECH Facebook



ITECH LinkedIn